

Eliminating Springback Error in U-Shaped Part Forming by Variable Blankholder Force

Gang Liu, Zhongqin Lin, Youxia Bao, and J. Cao

(Submitted 25 September 2000; in revised form 15 January 2002)

Springback is the main concern in U-shaped part forming, which would adversely affect desired part geometries. The use of variable blankholder force in the forming process is one effective method to reduce springback. However, there has not been a systematic way to determine the blankholder force trajectory. In this article, a methodology of obtaining this blankholder force trajectory in forming a U-shaped part that considers the wrinkling limit and fracture limit in the forming process was proposed. The method was validated numerically by using the Finite Element Method to simulate the benchmark of a 2-D draw bending problem in NUMISHEET'93. With the calculated blankholder force trajectory, higher forming quality was obtained and compared with constant blankholder force cases. Springback was kept at a minimum while avoiding cracking.

Keywords sheet metal forming; springback, U-shaped part, variable blankholder force

1. Introduction

U-shaped parts are one of the representative parts in sheet metal forming. This feature appears on many auto body cover panels such as side members and beams. Undesirable side wall curl, shown in Fig. 1, is the main defect in the U-shaped part's forming^[1] because it influences dimensional accuracy of parts and thus affects the subsequent assemblies. A recent trend in the auto industry of using aluminum alloy and high-strength steel to reduce vehicle weight and to improve safety makes this problem more severe.^[2,3]

The cause of sidewall curl in the forming of U-shaped parts is due to the complicated bending, unbending, and stretching deformations that the sidewall encountered. The stress distribution through the thickness of the sidewall under a low blankholder force (BHF) is shown in Fig. 2(a). The material points near the die surface have stresses in tension, and those near the punch surface have stresses in compression, resulting in a residual bending moment, which leads to the sidewall curl. Introducing a high blankholder force in the forming process is beneficial to the sidewall curl reduction. When the BHF is increased, namely, increasing the flow resistance of the material, the stress distribution can be altered as all the tensile stresses through the thickness of the sheet (Fig. 2b). Accordingly, bending moment is reduced, which decreases the shape distortion. However, although the BHF is increased, the tendency for sidewall cracking is also higher. To overcome this problem, a so-called "intermediate restraining" process was proposed by Liu^[4] to form a high-quality flanged channel.

Gang Liu, Zhongqin Lin, and Youxia Bao, School of Mechanical Engineering, Shanghai Jiaotong University, 1954 Huashan Road, Shanghai, People's Republic of China; and **J. Cao**, Department of Mechanical Engineering, Northwestern University, 2145 Sheridan Road, Evanston, IL 60208. Contact e-mail: gliu821@263.net.

Unlike the conventional BHF trajectory, shown in Fig. 3, the intermediate restraining process divides a forming cycle to two stages. The initial low blankholder force (BHF_1) is intended to ease the material flow. After a relatively long period, a high blankholder force (BHF_h) is applied to introduce large plastic strains in the sidewall, and the material in the flange area will no longer flow into the die cavity. In this process, the magnitudes of BHF_1 and BHF_h and the time (t_1) at which the blankholder force changes are the key process parameters to improve the forming quality of parts.

Variable blankholder force (VBHF) has shown its effectiveness in reducing springback or increasing the formability.

Nomenclature

BHF	blankholder force (kN)
BHF_1	low blankholder force (kN)
BHF_h	high blankholder force (kN)
t_1	the time, at which BHF_1 changes to BHF_h (s)
t_t	total time of the forming process (s)
E	Young's modulus (GPa)
μ	friction coefficient
ϵ_1	major strain (%)
ϵ_k	limited strain (%)
$\Delta\epsilon_{min}$	deformation redundancy (%)
Δz	z-direction displacement of flange's edge result from springback (mm)
FLD	forming limited diagram
ϵ_s	the strain of the lowest point of safety limit in FLD (%)
ϵ_{1max}	the largest engineering major strain on sidewall under BHF_1 (%)
$CBHF_{max}$	maximum CBHF (kN)
$CBHF_0$	initial CBHF (kN)
EPS	a small value
VBHF	variable blankholder force (kN)
ν	Poisson's ratio
CBHF	constant blankholder force (kN)

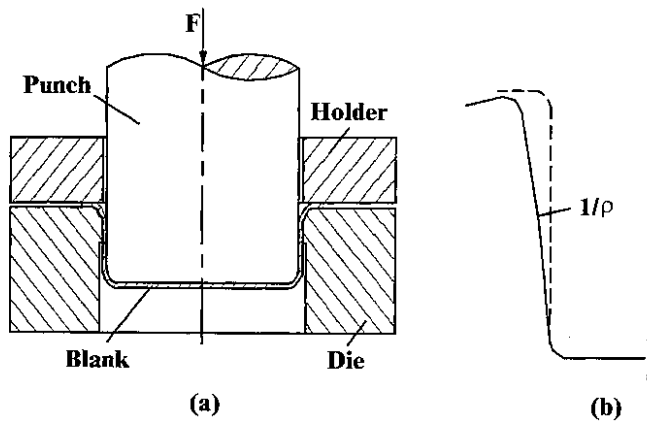

Fig. 1 Sidewall curve of U-shaped part

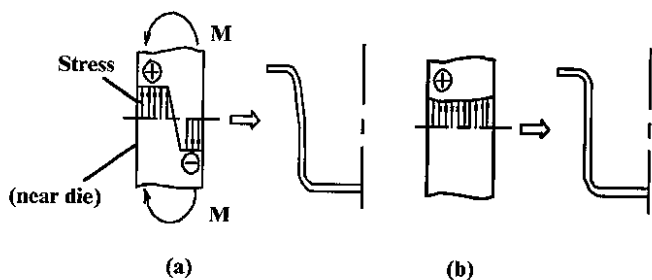

Fig. 2 Tangent stresses of material points on the sidewall

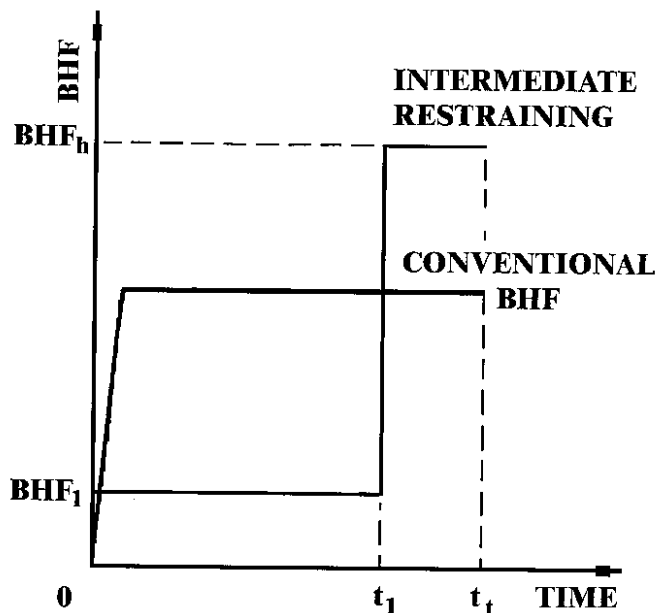

Fig. 3 Schematic of intermediate restraining in forming

Schmoeckel and Beth^[5] studied several BHF concepts in a typical component geometry of “hat-shaped section” by a model test. They indicated that a sudden increase of blank-holder force at the end of the forming process is particularly beneficial to the shape consistency. Sunseri et al.^[6] showed the effectiveness of VBHF in reducing springback and that of

closed-loop control in obtaining a consistent springback at the presence of friction variation. The work was further extended by Ruffini and Cao^[7] and Kinsey et al.,^[8] which numerically and experimentally, respectively, used a neural network to determine the magnitude of the higher BHF and where this change occurs. Although the approach was very robust for a wide range of materials and process conditions, the training data used for the neural network were obtained by trial and error approach. To our best knowledge, there is no reasonable method that can efficiently calculate the magnitudes of low and high BHF in a VBHF curve during a forming process.

In this article, the “intermediate restraining” method developed by Liu^[4] is reviewed first through a demonstration on the 2-D benchmark draw bending problem in NUMISHEET’93. The Finite Element Model we used and its predictability are presented by comparison with experimental data. Forming quality using this method is presented. Our new method is presented step by step followed by a comparison of forming quality under different forming conditions. Finally, a conclusion and summary are given.

2. Review of the “Intermediate Restraining” Method

When “intermediate restraining” is applied, indicated by Liu,^[4] forming quality is mainly dependent on BHF_1 , BHF_h , and t_1 (Fig. 3). Liu^[4] proposed that BHF_1 was to be just sufficiently high to prevent wrinkling and t_1 depended on the strain requirement in the sidewall. For example, a desired sidewall strain could be 14%, when the plane strain of the material is 16%, to eliminate springback error without cracking. If the effective sidewall length (after deducting corners’ radius of die and punch) at the end of drawing was 50 mm, because of the fact that the second stage will not allow any additional material drawn into the frustum region, the appropriate time to change BHF is when punch displacement remains 6 mm. This is calculated by equaling the approximated strain in the sidewall at the final stage, $6/(50-6)$, to the desired 14%.

There are two problems in “intermediate restraining” which are worth mentioning. (1) BHF_1 is to prevent wrinkling. However, its value is difficult to estimate. (2) No clear method was given to determine BHF_h . Thereby, unfit values of BHF_1 and BHF_h could result in cracking on the sidewall or having no distinct effect on increasing dimensional accuracy. For the sake of illuminating this problem, the 2-D draw bending problem in NUMISHEET’93 has been used to numerically investigate the effect of VBHF on springback elimination.

2.1 2-D Draw Bending Problem

The geometry of the 2-D draw-bending problem in NUMISHEET’93 is shown in Fig. 4. Dimensions of the aluminum alloy blank is 350 mm long, 35 mm wide, and 0.81 mm thick. The material properties are listed below: $E = 71$ GPa, $\nu = 0.3$, $\mu = 0.162$, $\sigma = 579.79(0.01658 + \epsilon^n)^{0.3593}$ MPa. Punch displacement is 70 mm.

A one-quarter finite element model has been built according to symmetry. The forming process was simulated by a commercial finite element package LS-DYNA using the explicit integration method. The Belytschko-Tsay element with seven

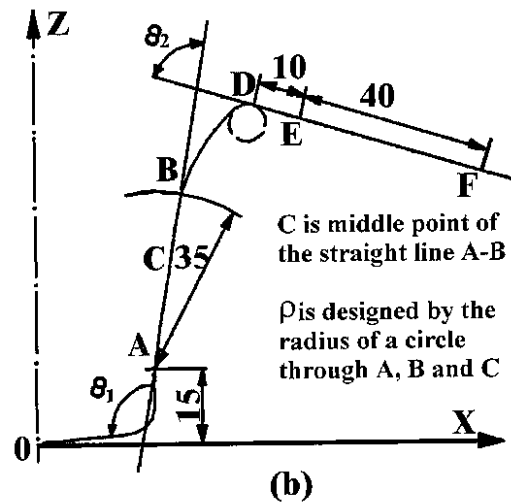
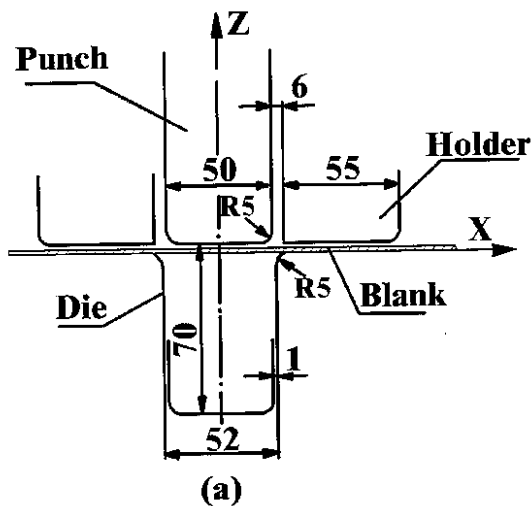

Fig. 4 2-D draw bending problem of NUMISHEET'93: (a) geometry; (b) measuring method

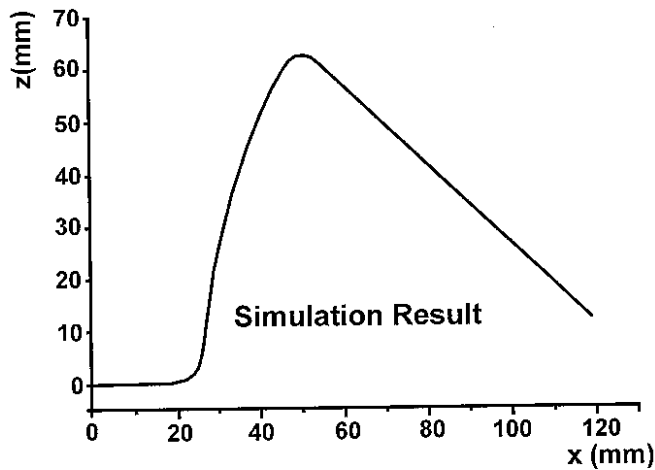

Fig. 5 Profile of part after springback

integration points through the sheet thickness direction was used to describe the blank. The three-parameter Barlat material model was chosen to account for the anisotropic elastic-plastic property of the blank. Punch's velocity was kept at a constant speed of 10 m/s during the forming simulation. Springback simulation was accomplished by LS-NIKE3D using the implicit integration method. Simulation results at a constant blankholder force (CBHF) of 2.45 kN are shown in Table 1 and Fig. 5. From the comparison between simulation results and average experimental data offered by NUMISHEET'93, good agreement is obtained, which indicates that our model is accurate.

2.2 Evaluation of Concepts of Forming Quality

Cracking, wrinkling, and springback are main defects in sheet metal forming. There is no wrinkling problem during the forming process of U-shaped parts. Therefore, here, we evaluate the forming quality from the aspect of cracking and spring-

Table 1 Simulation Results

	θ_1 (°)	θ_2 (°)	ρ (mm)
Simulation	108.6	71.8	124.1
Avg. (Exp.)	112.4	72.8	106.0

back error. We introduced two concepts to evaluate forming quality and illustrated them by simulation results under a CBHF of 2.45 kN.

One concept is deformation redundancy used to judge whether cracking occurred during a forming process. It is defined by the difference between the major deformation strain ϵ_1 and the limited strain ϵ_k in the forming limit diagram. The minimum difference is called deformation redundancy ($\Delta\epsilon_{\min}$) as shown in Fig. 6(a). Cracking is not considered to be appearing when $\Delta\epsilon_{\min}$ is larger than 8-10%¹ and 8% of $\Delta\epsilon_{\min}$ is named as the "safety limit." At the same time, we found plastic strain in the sidewall is not uniform even if under a very low BHF as shown in Fig. 6(b). The maximum thickness reduction is near the punch radius, and that position is the so-called "dangerous section." The other concept is the z-direction displacement of flange's edge (Δz) resulting from springback as shown in Fig. 6(c).

Under a CBHF of 2.45 kN, $\Delta\epsilon_{\min}$ is 25.3% and Δz is 58.82 mm after forming, which indicate that forming is very safe, and shape deviation is notable as well. The ultimate goal of our process design is to have $\Delta\epsilon_{\min}$ close to 8% and Δz to be 0.

2.3 Primary Analysis of VBHF's Effect on the Forming Quality of a Part

Based on the principle of "intermediate restraining," we selected the BHF₁ as 2.45 kN because the engineering major strain after the forming process under a CBHF of 2.45 kN is slight—2.752%. BHF_h was selected as 50 kN to prevent the flange material from flowing to the die cavity. That value was large enough because cracking occurred as soon as the punch displacement reached 10 mm under a CBHF of 50 kN. "Safety

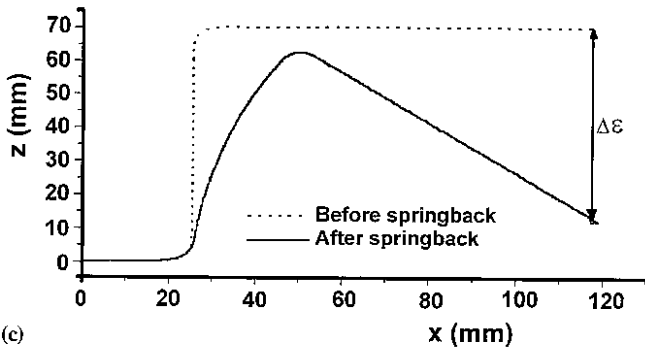
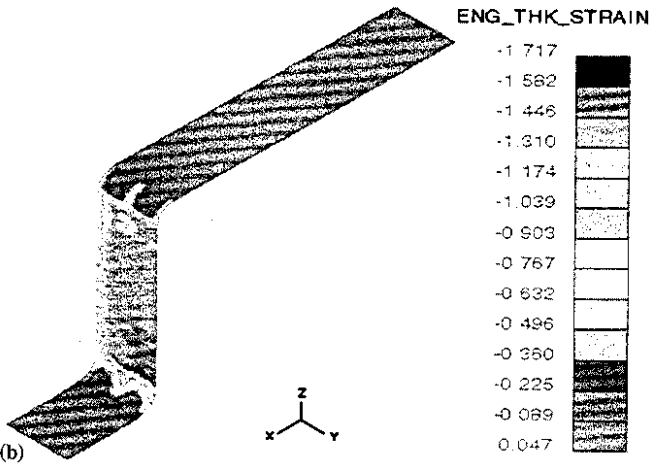
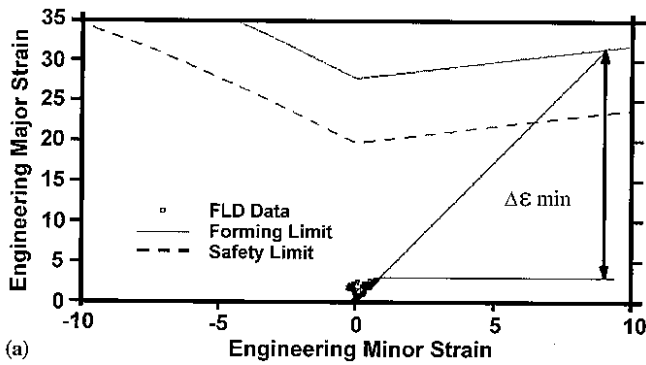

Fig. 6 Simulation results under CBHF of 2.45 kN: (a) forming limited diagram; (b) distribution of engineering thickness strain; (c) profiles before and after springback

limit" strain, or the desired strain in the sidewall, is about 20%, which is taken from the lowest point of the safety limit in FLD and recorded as ϵ_s . Then the t_1 in Fig. 3 could be estimated by the equation listed below:

$$\frac{x}{1-x} = 0.20 \quad (\text{Eq 1})$$

Here x is the ratio of t_1/t_0 , as shown in Fig. 3. This gives x about 83.33%.

Simulation results of the forming process under this VBHF curve (2.45 kN/50 kN) are shown in Fig. 7. We can see from Fig. 7(a) that the current deformation redundancy is very small.

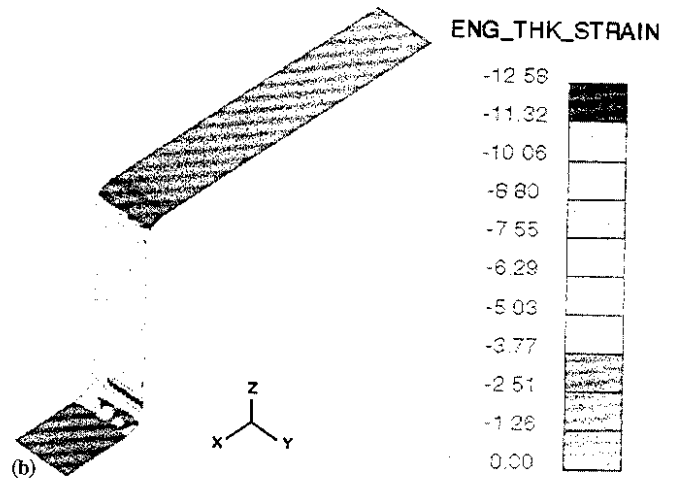
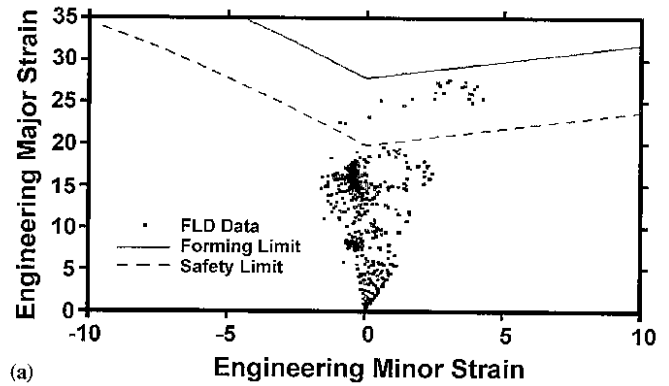

Fig. 7 Forming results under VBHF of 2.45 kN/50 kN: (a) forming limited diagram; (b) distribution of engineering thickness strain

Some elements' strains are very close to the limit strain. In other words, cracking may be occurring. Therefore, this VBHF curve could not meet our requirement. The main reason for this problem lies in the fact that plastic strain in the sidewall of a U-shaped part is not uniform even if under CBHF. Consequently, the dangerous section might have suffered excessive reduction in thickness under application of BHF₁ after the blank deformed at BHF₁ and had uneven plastic strains in the sidewall. As shown in Fig. 7(b), engineering major strain near the punch radius is about 12.58%, which is much larger than 6% of other areas in the sidewall.

The above analysis indicated that if the values of BHF₁ and BHF_h are unfit, a U-shaped part's forming quality could not be improved.

3. A New Method to Determine the VBHF Curve

Aiming at the above problems in the "intermediate restraining" method, we developed a new way to determine BHF₁ and BHF_h, by which they could be obtained easily and more reasonably. The forming process at a fixed blankholder gap is simulated to obtain BHF₁. An experiential equation and an extrapolate method are presented to obtain BHF_h. In the following, the new method is described in detail first. Then, it will

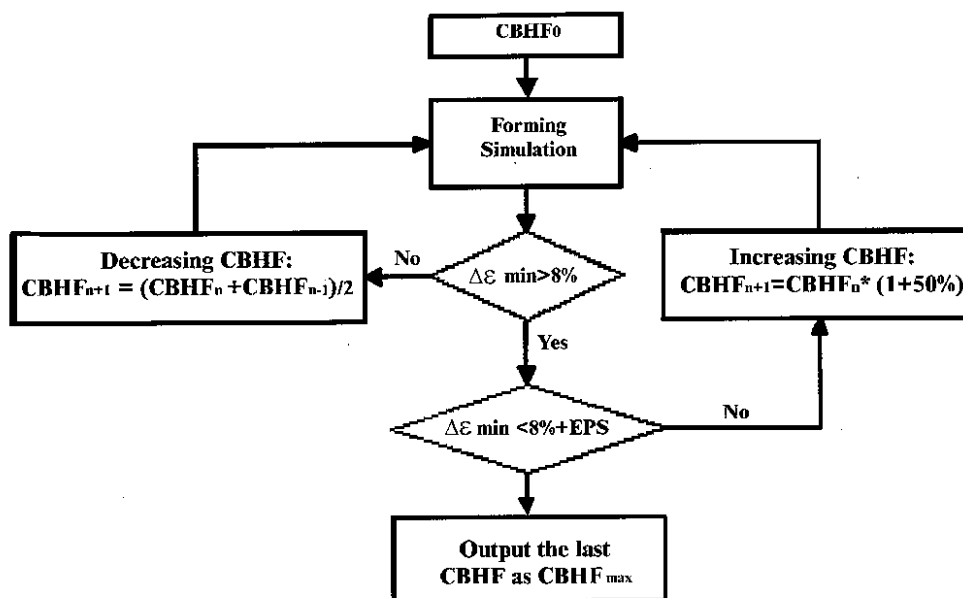

Fig. 8 Searching method of $CBHF_{max}$

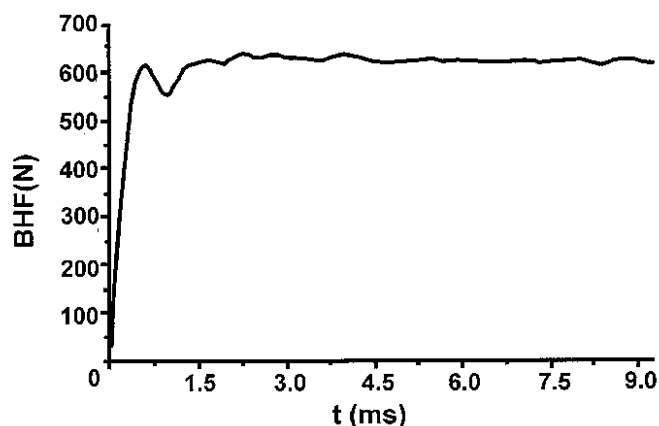

Fig. 9 Actual BHF under fixed blank holder gap

be applied in the simulation of the forming process of a U-shaped part to validate it.

3.1 Determination of BHF_1

BHF_1 should be selected to be as small as possible under the precondition that it can clamp the blank. Thus, plastic strain in the sidewall will be low and the distribution more even, which is desirable for subsequent forming. In the numerical simulation, BHF_1 could be obtained by "trial and error," which is time-consuming. In practice, there is an action mode to control the blankholder in a forming process, which uses a blankholder force or a fixed gap between the blankholder and the die. The value of BHF_1 could be easily obtained by simulating the forming process under a fixed blankholder gap. Because no wrinkling problem exists in the forming of a U-shaped part, a gap of 1.1 times the blank thickness is assigned to ensure the free flow of the blank material. Then, the reaction force pressed on the blank during the forming process could be recorded to help

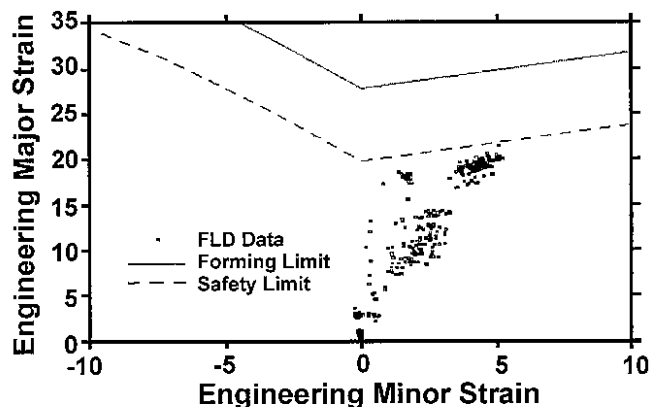

Fig. 10 Forming limited diagram under $CBHF$ of 27 kN

determine the BHF_1 . The largest engineering major strain on the sidewall as ϵ_{1max} is also recorded.

3.2 Determination of BHF_h

To avoid cracking on the sidewall during the forming process, BHF_h was taken from the largest $CBHF$ ($CBHF_{max}$) deformation under which it met safe limits in a forming process with a constant blankholder force. In practice, $CBHF$ usually depends on the experiential equation as given below:

$$CBHF_0 = Aq \quad (\text{Eq 2})$$

where A is the effective clamp area of the blank between the blankholder and die's flange before the deformation and " q " is 0.8 to 1.2 MPa/m^2 for aluminum and 2.0×2.5 MPa/m^2 for steel. Usually, $CBHF_0$ gained by this equation is in the middle of the safe $CBHF$ range, which could be applied in sheet metal forming. On the basis of $CBHF_0$, we used an extrapolate

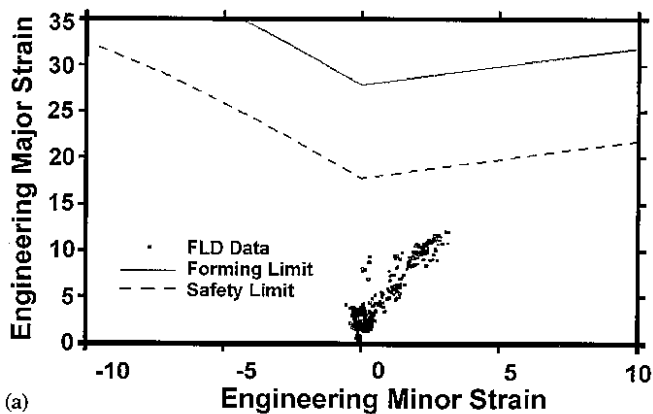

(a)

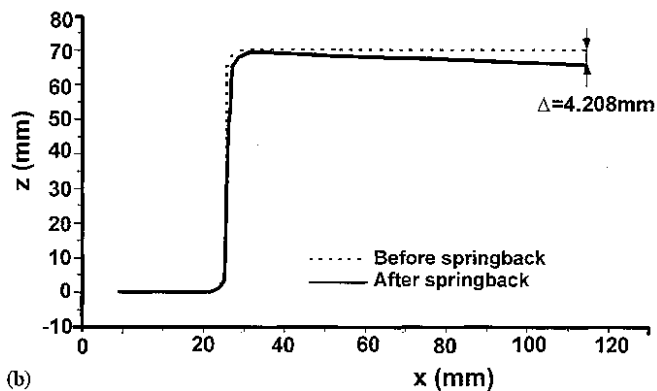

(b)

Fig. 11 Simulation results under VBHF of 0.62/27 kN: (a) forming limited diagram; (b) profiles before and after springback

Table 2 Simulation Results of Different BHF

BHF (kN)	Max. Eng. Major Strain (%)	Max. Thickness Reduction (%)	$\Delta\epsilon_{\min}$ (%)	Δz (mm)
2.45	2.752	1.717	25.3	58.82
19.6	15.09	8.508	14.3	28.41
27	21.44	11.23	8.35	7.567
0.62/27	12.00	6.749	16.99	4.208

method, illustrated in Fig. 8, to obtain $CBHF_{\max}$, where EPS is a small value. Generally, $CBHF_{\max}$ or BHF_h could be obtained through three to five iterations.

3.3 Application in the Forming Process of U-Shaped Parts

The above method of determining the VBHF curve is now being applied in forming of the 2-D draw bending problem in NUMISHEET'93 to show its effectiveness. The actual force pressed on the blank during the forming process under a fixed blankholder gap of 1.1 times the blank thickness is shown in Fig. 9. The force began to increase when the punch contacted with the blank and stabilized at 620 N after 1.5 ms. Therefore, the BHF_1 was selected as 620 N or 0.62 kN. The largest engineering major strain in the sidewall under this condition is only 1.175%.

The determination of when to change the blankholder force is the same as that in Eq 1 reported by Liu,^[4] which gives a change at 83.3%. The search for the high blankholder force is as follows. The effective clamp area of the blank, A in Eq 2, is 10,080 mm², which results in $CBHF_0$ to be between 8 and 12 kN. If we took it as 12 kN, $\Delta\epsilon_{\min}$ under this $CBHF$ is 19.44%, which is much larger than 8%. The succeeding searching process was the following: $CBHF_1 = 18$ kN and $\Delta\epsilon_{\min} = 13.55\%$, $CBHF_2 = 27$ kN, and $\Delta\epsilon_{\min} = 8.35\%$. Hence, BHF_h was taken as 27 kN. The forming limited diagram under a $CBHF$ of 27 kN is shown in Fig. 10.

After the determination of BHF_1 , BHF_h and t_1 , the forming process of the U-shaped part under such a VBHF was simulated. Results are shown in Fig. 11, where $\Delta\epsilon_{\min} = 16.99\%$ and $\Delta z = 4.208$ mm. It could be said that fine forming quality has been made.

4. Discussion

To compare the effect of minimizing the springback amount under different blankholder forces, simulation results of several $CBHF$ and $VBHF$ of 0.62 N/27 kN are listed in Table 2. Notice that Δz was very large under a $CBHF$ of 2.45 kN. With the increasing of $CBHF$, Δz decreased quickly along with decreasing in $\Delta\epsilon_{\min}$. When $CBHF$ was 27 kN, $\Delta\epsilon_{\min}$ was 8.35%, which is very close to the safety limit. Further increasing $CBHF$ would result in cracking in the sidewall. Forming quality of 0.62/27 kN $VBHF$ was better than that of 27 kN $CBHF$ in both avoiding cracking and improving dimensional accuracy. The main reason for these phenomena lay in the different flow velocities of material under different BHF. As a result, the flange length of the blank after the forming process was 81.4 mm under a $VBHF$ of 0.62/27 kN against 86.6 mm under a $CBHF$ of 27 kN.

To analyze the cause of different effects on springback elimination of the above BHF's, we selected three points on the sidewall of the U-shaped part and plotted the tangential stress through the thickness of these locations as shown in Fig. 12. The z-direction distances from point A, B, and C to Point O are, respectively, 20, 35, and 50 mm. Under the $CBHF$, even if the blankholder force was selected to be as high as possible, Δz was still large because of the uneven stress distribution through the thickness. When a $VBHF$ of 0.62/27 kN was adopted, the entire section of sidewall become a stretching deformed area, and the stress distribution was more uniform than that of 27 kN $CBHF$. Accordingly, the best dimension accuracy was obtained.

5. Conclusions

A new method was proposed in this article based on the analysis of an "intermediate restraining" method to eliminate springback error in a U-shaped part by variable blankholder force, by which BHF_1 , BHF_h , and t_1 in the VBHF curve could be easily determined. The procedure is illustrated below:

- 1) Simulate a forming under a fixed blankholder gap of 1.1 times the blank thickness. Record the steady-state blankholder reaction force as BHF_1 .

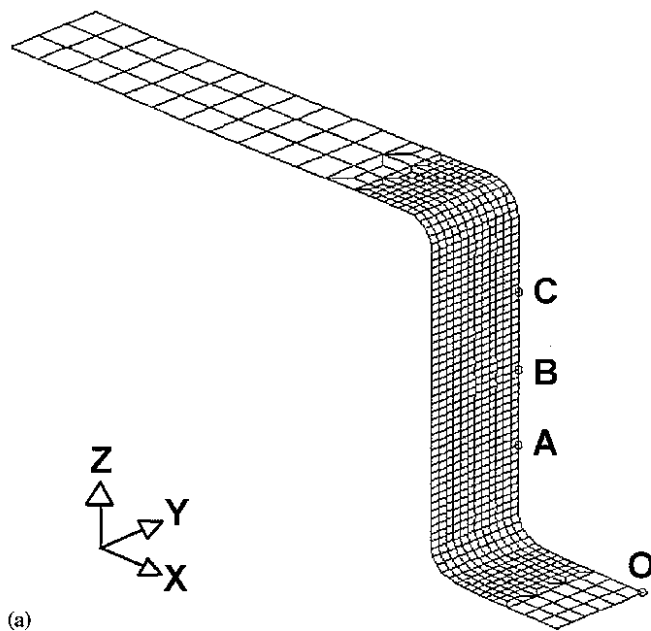

(a)

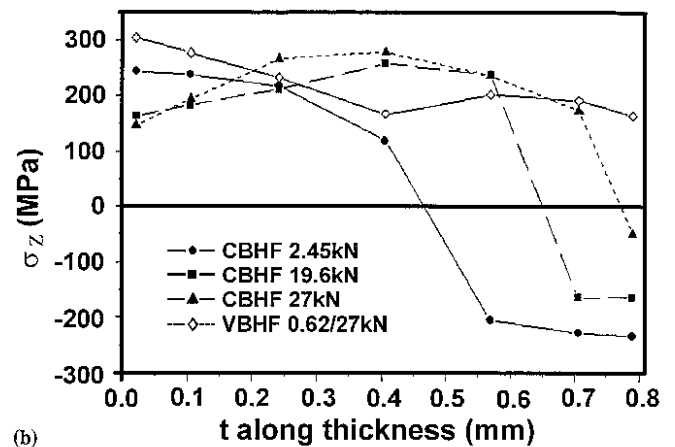

(b)

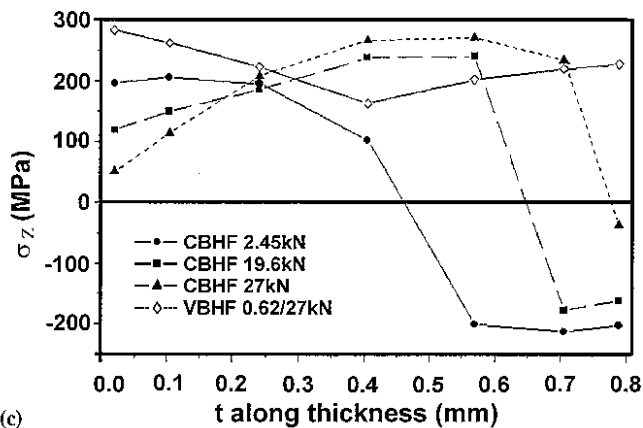

(c)

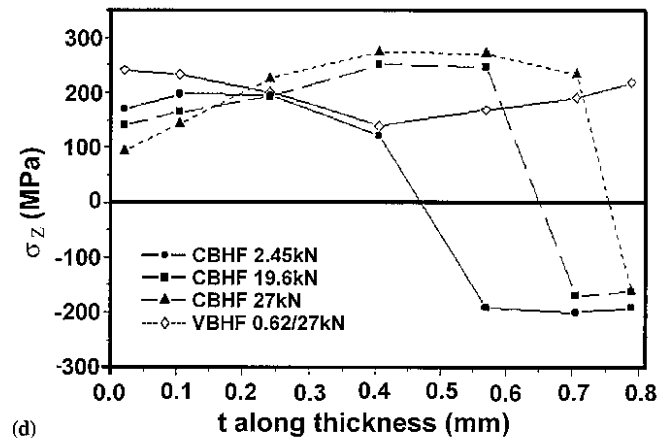

(d)

Fig. 12 Tangential stress distributions through the thickness on sidewall: (a) position of measure points; (b) point A; (c) point B; (d) point C

- 2) Use Eq 1 to obtain t_1 , the time when the blankholder force is changed.
- 3) BHF_h could be taken to be the same as $CBHF_{max}$, which could be gained by an experiential equation and an extrapolate method.

The method has been applied in the forming process of the 2-D draw bending problem in NUMISHEET'93. When a VBHF of 0.62/27 kN was adopted, compared to a $CBHF_{max}$ of 27 kN, the strain allowance, $\Delta\epsilon_{min}$, increased from 8.35 to 16.99%, meaning a safe drawing, and the tip displacement, Δz , decreased from 7.567 to 4.208 mm, meaning less springback. The improvement of forming quality is due to the evenness of the tangential stress distribution through the thickness in the sidewall by imposing this VBHF trajectory (Fig. 12). It indicated that better forming quality of a U-shaped part could be obtained by using VBHF in the forming process, which can be easily determined by the new method.

References

1. Y.Y. Yang: *Complicated Sheet Metal Forming Technology*, National Defense Publication, Piking, 1996, pp. 106-7.
2. M. Kawka, A. Makinouchi, and S.P. Wang: "Simulating Manufacturing Processes," *Automotive Engineering*, 1997, 105(4), pp. 31-33.
3. K. Kazama, T. Nukaga, and H. Makino: "Springback Simulation of Truck's Frame Side Member" in *Proceedings of NUMISHEET'99*, J.C. Gelin and P. Picart, ed., University of the Franche-Comte and ENSMM Besancon, 1999, pp. 65-70.
4. Y.C. Liu: "The Effect of Restraining Force on Shape Deviation in Flanged Channels," *J. Eng. Mater. Technol.*, 1988, 110, pp. 389-94.
5. D. Schmoekel and M. Beth: "Springback Reduction in Draw Bending Process of Sheet Metals," *Annals of the CIRP*, 1993, 42(1), pp. 339-42.
6. M. Sunseri, J. Cao, and A.P. Karafillis: "Accommodation of Springback Error in Channel Forming Using Active Blankholder Force Control: Numerical Simulations and Experiments," *J. Eng. Mater. Technol.*, 1996, 118(3), pp. 426-35.
7. R. Ruffini and J. Cao: "Using Neural Network for Springback Minimization in a Channel Forming Process," *Proceedings of the 1998 SAE International Congress & Exposition*, 1998, pp. 77-85.
8. B. Kinsey, J. Cao, and S. Solla: "Consistent and Minimal Springback Using a Stepped Blankholder Force Trajectory and Neural Network Control," *J. Eng. Mater. Technol.*, 2000, 122, pp. 113-18.